

EBS | Innovation since 1977

# HANDJET® EBS® -260

PRINT  
EVERYWHERE



# Handjet EBS-260

A state-of-the-art portable inkjet printer which takes product marking and coding to another level.

It is light, handy and wireless. The printer is fully portable and versatile – you can print customized messages in almost every language on many different types of surfaces.

It will print text, graphics, 1D and 2D barcodes.

Create and edit programmed messages instantly.

Forward and reverse printing on almost any surface.

Large capacity rechargeable Li-Ion battery ensures long operating time.



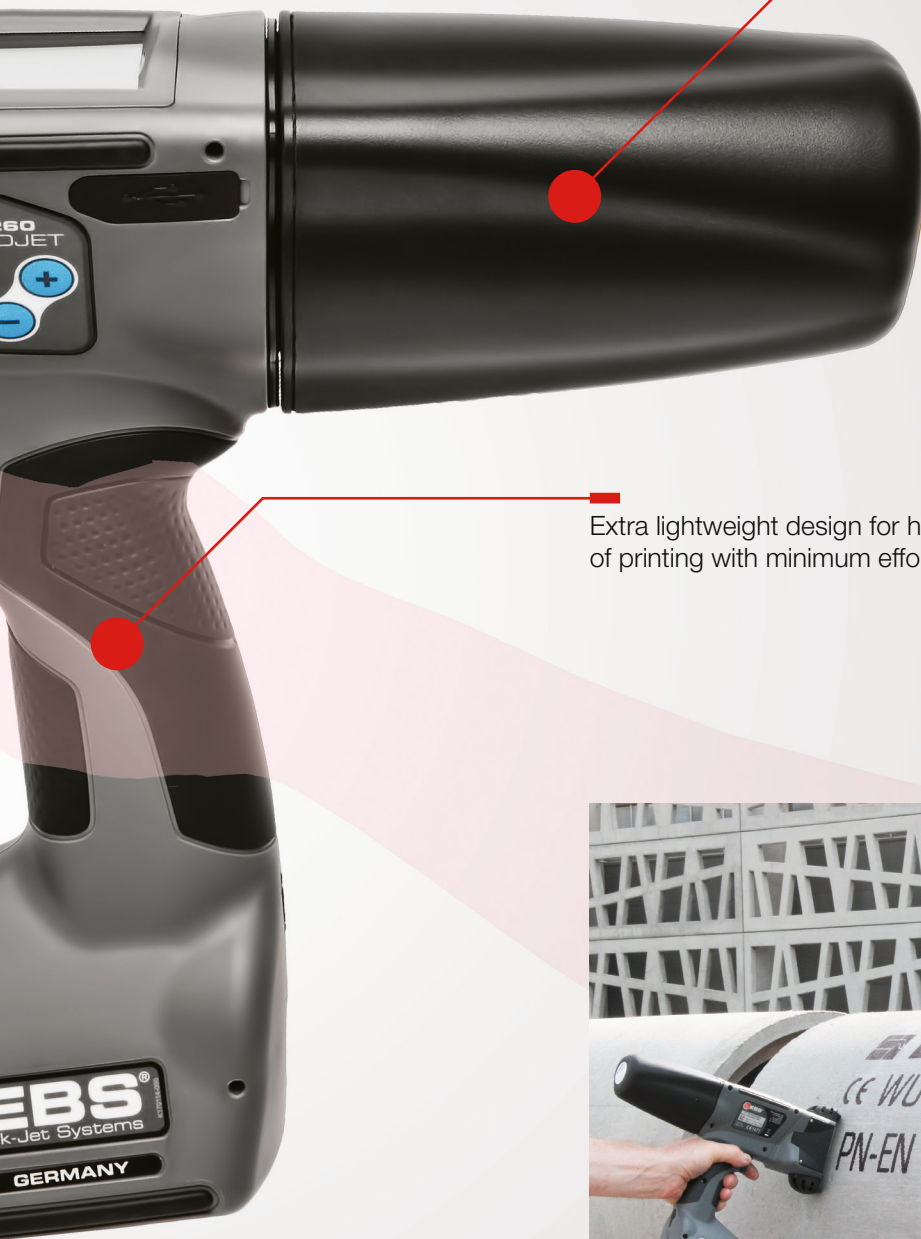

A selection of high-quality inks is available for various surfaces.

Extra lightweight design for hours of printing with minimum effort.



Save time & effort:  
take the Handjet EBS-260 to the product.

# Printing capabilities



Clear, crisp print on wood and timber, including pallets and logs.

Prints on glass.



Can be used to mark building materials.



Can be used to easily mark concrete blocks, tiles, barrels, concrete ducts, etc.



Prints on large-size elements that cannot be moved.



Prints on uneven, porous surfaces.

Allows for printing on difficult-to-reach parts and elements of industrial installations.



Suitable for printing on rubber, elastomers, and other plastics; boxes, tanks, barrels, and containers of different sizes.



Provides a good quality print on both smooth and wrinkled stretch, as well as on bubble wrap.

Ensures a quality print on pipes and/or their insulation.



Prints with contrast on fluffy fabrics and carpets.

Prints on polystyrene.



**And you?  
What would you  
like to mark?**

Why the  
Handjet ...

... IS SECOND  
TO NONE IN  
THE MARKET

### Independence

A built-in touchscreen controller enables offline message creation and edition, which is handy for those doing fieldwork.



### Large memory

Can store 50,000 projects, or more.

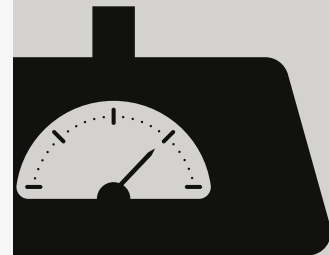
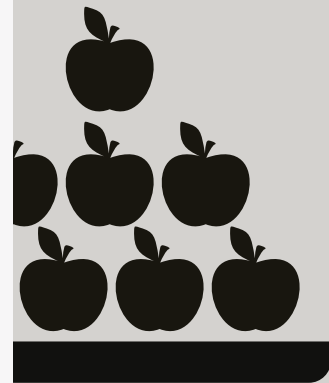

### Lightweight design

The printer weighs the same as 8 apples.

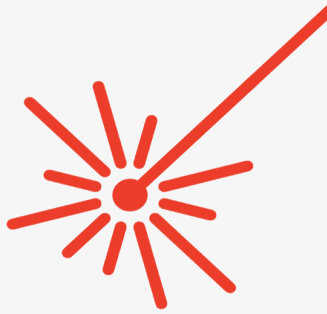

### Precision

Prints in straight or semi-circular lines; additional adapters ensure that messages are printed in perfectly straight lines.



### Performance

The printer can work up to 2 days.



### Speed

A single box can be properly marked in only 5 seconds.



### Practical

Don't waste time and money on transporting products to a printing site. Take your printer to the product.

### Printing in different positions

You can print easily on difficult-to-reach surfaces. The valvejet technology makes printing at any angle so easy.

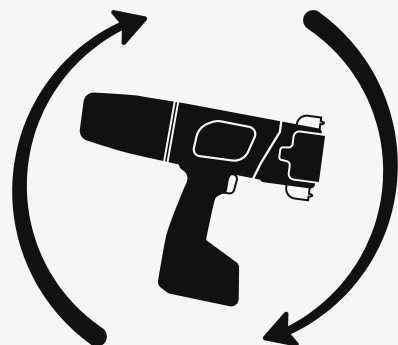

# Technology



## Touchscreen

Allows you to create and edit messages in an instant and monitor print status.



## Cartridge

Holds ink for up to 200,000 characters. Replacing a cartridge takes only seconds. Due to its unique design ink waste is reduced to 1%.

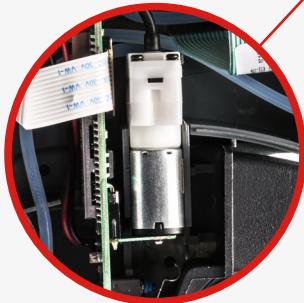

## Microprocessor-controlled compressor

Best quality of printing is guaranteed through steady pressure.



## Printing in any position

You can print easily on difficult-to-reach surfaces. Printing at **any** angle has never been so easy.



## Li-Ion Battery

Mobile printing at its best!  
Printing on site?  
No power cord necessary for up to 16 hours.

Part number: P350146000-150423





## Communication

Numerous possibilities of communication – WiFi, Bluetooth, USB. A fast and easy way of importing and transporting data from external devices like computer or code readers.



## Deflector

Special nozzle plate design prevents smudging; especially on uneven, soft and flexible surfaces.



## Complex capabilities

Prints up to 5 lines in one stroke, graphics, barcodes, inverse texts, variable data and much more.

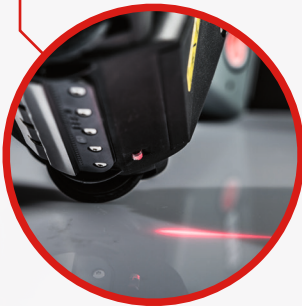

## Built-in laser

Align your printing.



## Smart sensing

No matter if you move fast or slow, the Handjet will adapt to the speed of your hand.

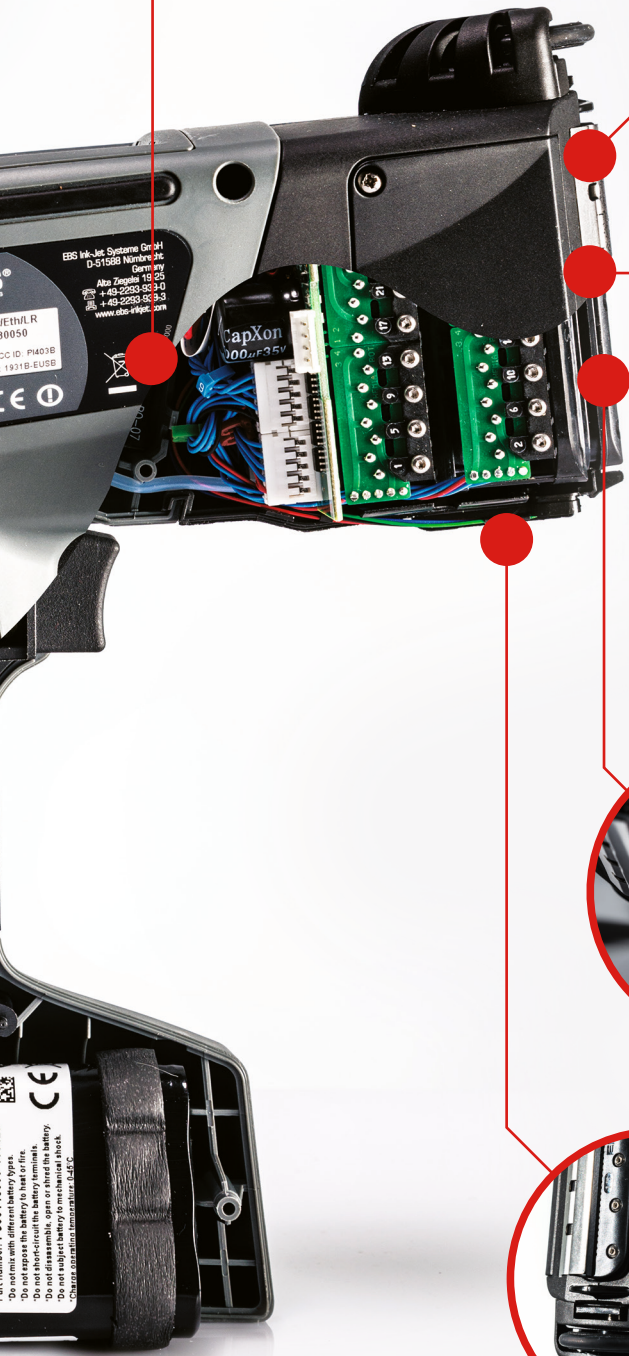

# Accessories

## Included\*

The printer is available in a convenient carrying case, which can be used both for storage and transport.

The entire set includes a power adapter (24V/1.25A), for recharging the batteries, power adapter cable, two standard rollers, two large rollers, Software CD and a spray bottle for ink cleaner.



## Supporting stabilisers

Additional equipment such as supporting stabilisers for different applications, like printing a perfect straight line, for printing on cylindrical surfaces or round objects.



→ **Supporting circular printing**



→ **Printing on flat surfaces with stabiliser for printing in a straight line.**



→ **Axial printing on cylindrical surfaces**

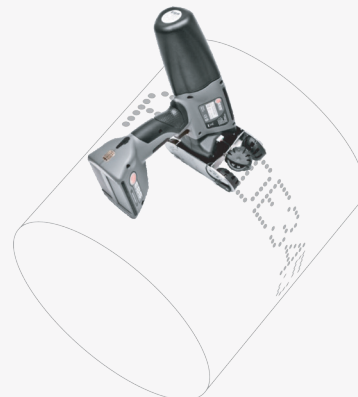

→ **Radial printing on cylindrical surfaces**

\* configurations may vary

# Technical data

<b>Number of nozzles</b>	32
<b>Nozzle diameter</b>	150 µm
<b>Print height</b>	from 11 mm (0.43") to 57 mm (2.24")
<b>Min. height of object to be printed</b>	> 39 mm (1.54")
<b>Text separation</b>	selectable in successive lines
<b>Printer memory</b>	8 GB, equals 50,000 messages or more
<b>Number of text lines in one stroke</b>	up to 5 lines (for 5x5 dot text matrix)
<b>Print lines</b>	using multiple lines in one design: up to 10 printouts in one message (e.g. various contents in different places on an object).
<b>Special characters</b>	Graphic symbols, warning or transport marks, etc. – free raster graphics up to 32 dots in height.
<b>Battery Power</b>	Battery – 6 Li-Ion battery pack Capacity: 4400 mAh
<b>Operating time with full battery</b>	up to 16 hours (Calculated for 60 printouts of 1 m in length, 550 dots/meter per hour, at about 20°C.)
<b>Recharging</b>	charging time – approx. 300 minutes (< 5 h)
<b>Cartridge volume</b>	200 ml
<b>Operating pressure</b>	0.015 MPa up to 0.045 MPa (0.15 bar up to 0.45 bar)
<b>Operating temp. range</b>	from +5°C to +40°C (from 41°F to 104°F)
<b>Storage temp. range</b>	from + 1°C to +45°C (33.8°F to 113°F) for printer with water-based ink from -10°C to +45°C (14°F to 113°F) for printer with MEK- or ethanol-based inks
<b>Humidity</b>	up to 95% without steam condensation

## Inks

Our dye-based and pigmented inks are made on the basis of:



**Ethanol -  
universal ink**



**Acetone -  
fast-drying**



**Methyl Ethyl  
Ketone (MEK) -  
super fast-drying**



**Water -  
environmental-  
friendly for porous  
substrates**



Plant Nümbrecht - Germany



## PRODUCTION & DEVELOPMENT

### HEADQUARTERS GERMANY

EBS Ink Jet Systeme GmbH  
Alte Ziegelei 19-25  
51588 Nümbrecht-Elsenroth  
Deutschland  
Tel: 0 22 93 / 93 9-0  
Fax: 0 22 93 / 93 9-3  
E-Mail: mail@ebs-inkjet.de  
www.ebs-inkjet.de

### POLAND

EBS Ink-Jet Systems Poland Sp.z o.o.  
ul. Tarnogajska 13  
50-512 Wrocław (Breslau)  
Polen  
Tel: (+48) 71 36 70 411  
Fax: (+48) 71 37 33 269  
E-Mail: office@ebs-inkjet.pl  
www.ebs-inkjet.pl

## SALES, LOGISTICS & TECHNICAL SUPPORT

### USA

EBS Ink-Jet Systems USA, Inc.  
1840 Industrial Drive - Suite 200  
Libertyville, IL 60048  
USA  
Tel: (001) 847 996 0739  
Fax: (001) 847 996 0843  
E-Mail: sales@ebs-inkjet.com  
www.ebs-inkjet-usa.com

### CHINA

EBS Ink-Jet Systems  
(SHENZHEN) Co., Ltd.  
Unit 608, Building Jin-Hui-Qiu No.5,  
Langshan 2nd Road, Gaoxin bei qu,  
Nanshan District  
518057 Shenzhen China  
Tel: (+86) 755 2340 0676  
Fax: (+86) 755 2340 0376  
E-Mail: office@ebs-china.com  
www.ebs-inkjet-china.com



# EBS | 42 Years of Competence and Innovation

Since 1977, EBS GmbH Germany has been a leader in industrial coding equipment. Our early development and pioneering innovations in ink-jet technology are still being used world wide.

Today EBS has become an international producer and operates a family owned multi-national business. We run branch offices and plants in Europe, USA and China and co-operate with numerous partner companies world wide.

More than 330 people develop and produce the range of EBS products in Germany and Poland. We continue to set global standards for quality, innovation, technological leadership and service.

Our high performance products can be found in more than 70 countries, with more than 200 distributors, dealers and OEM's.

We would like to welcome you as our new customer.

[www.ebs-inkjet.de](http://www.ebs-inkjet.de)

Your Dealer